



变压器铁芯剪切线机器人叠片臂系统【P20】 专利产品
3G Automatic Cutting Line Integration System with Robotic Arm Stacking



Made in Canada

【P20】多铁柱理料堆垛叠片模式示意图

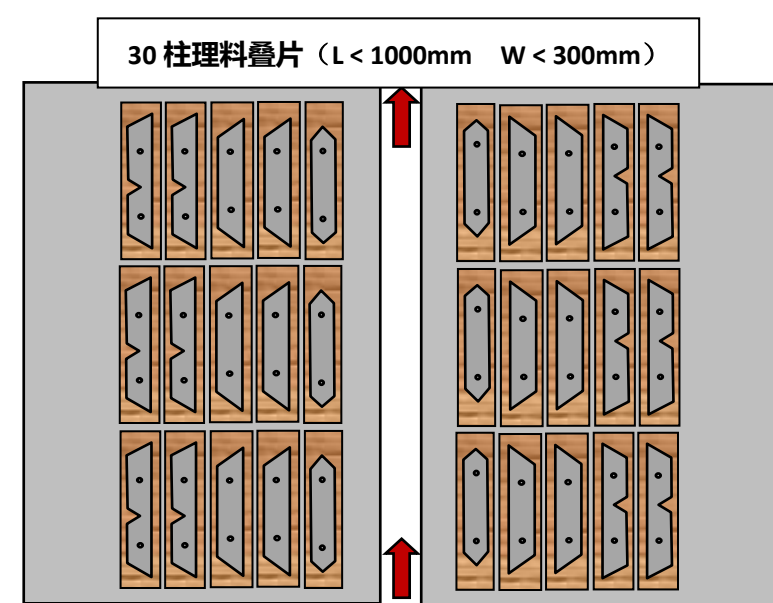
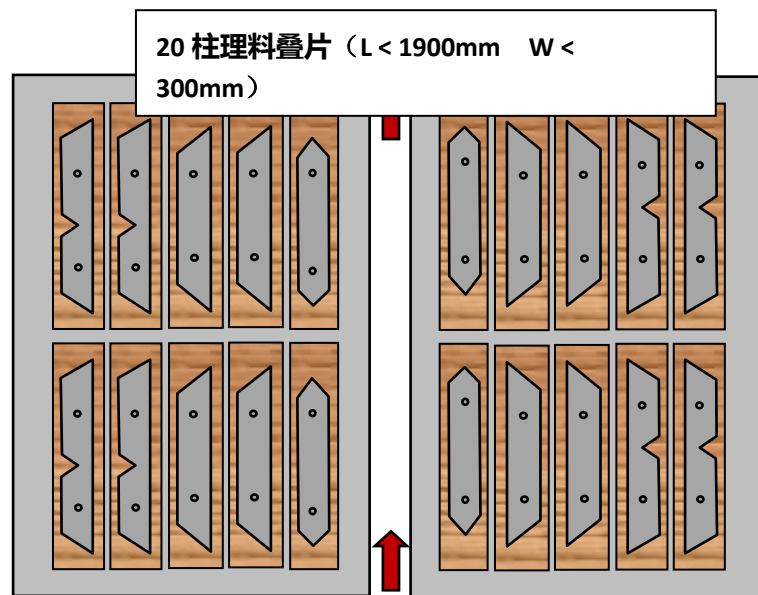
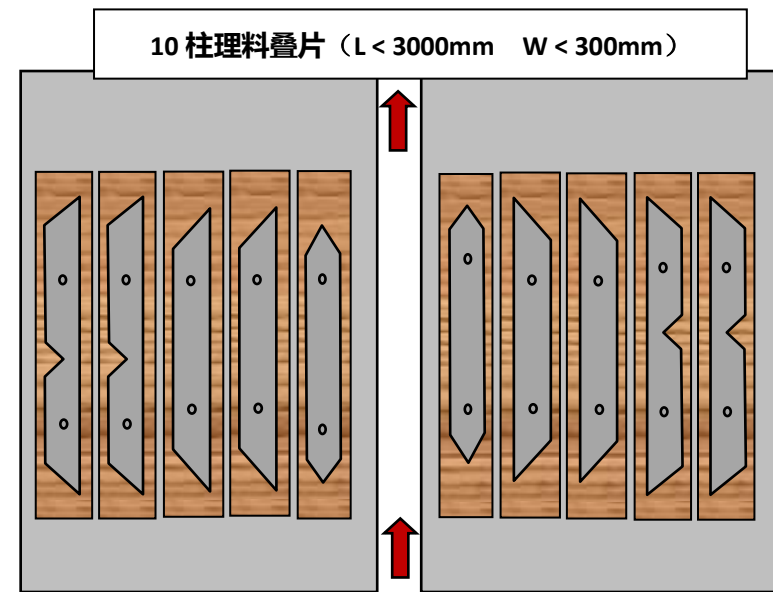
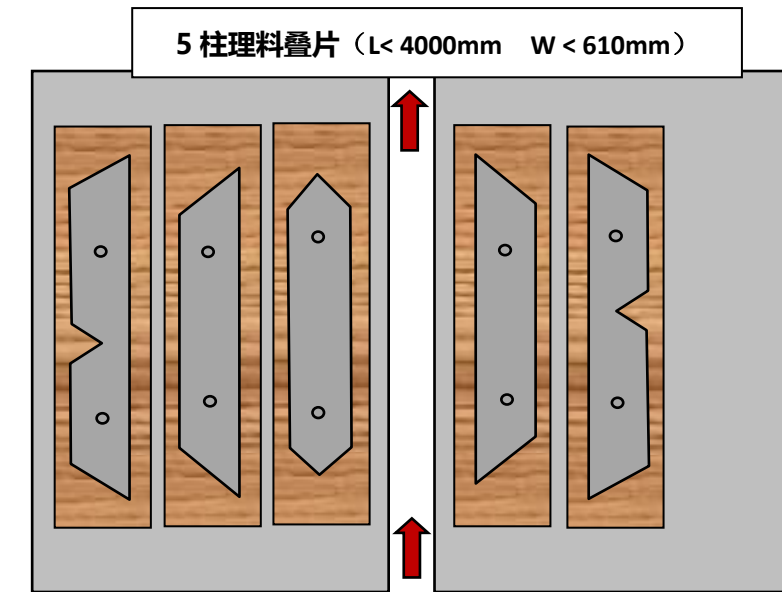

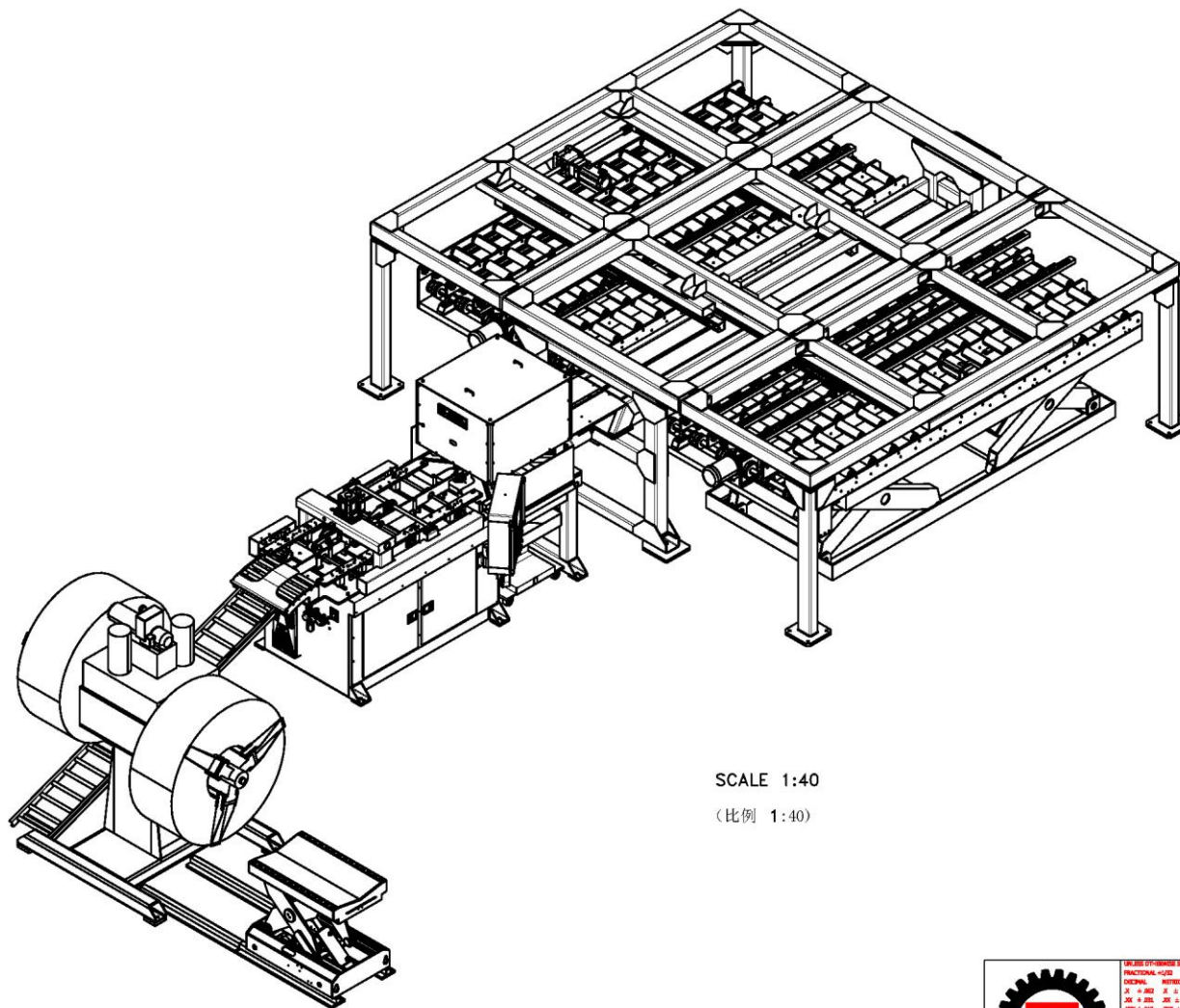



SCALE 1:40

(比例 1:40)

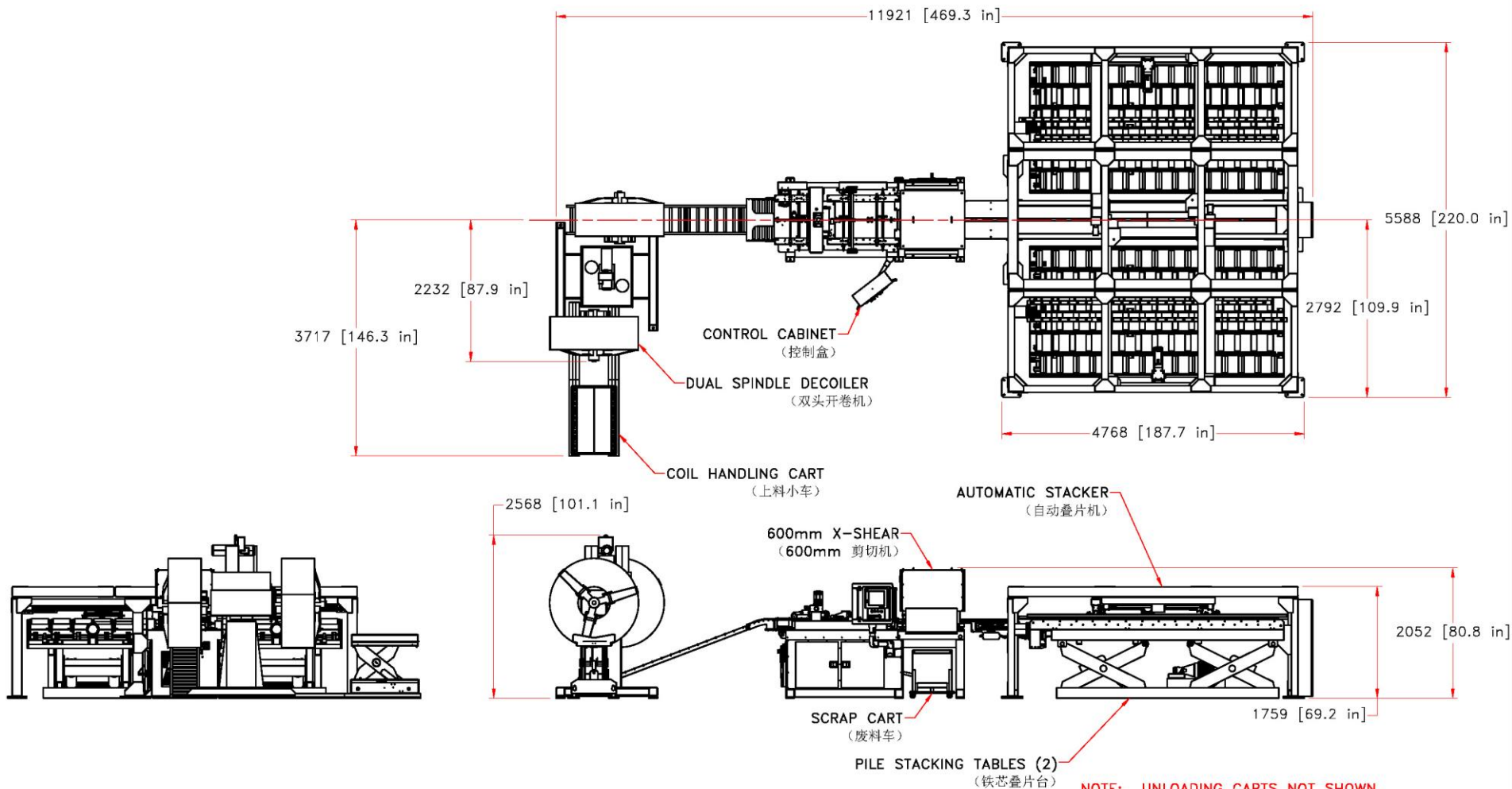
	<p>UNITS OF DIMENSION SPECIFIED FRACTIONS - 1/16 DECIMALS - NONE SI - 1/16 IN. EQ. 1.5875mm 1/8 IN. EQ. 3.175mm 3/16 IN. EQ. 4.7625mm 1/4 IN. EQ. 6.35mm 5/16 IN. EQ. 7.9375mm 3/8 IN. EQ. 9.525mm 1/2 IN. EQ. 12.7mm 5/8 IN. EQ. 15.875mm 3/4 IN. EQ. 19.05mm 7/8 IN. EQ. 22.225mm 1 IN. EQ. 25.4mm</p>	<p>This print is the property of Micro Tool & Machine Ltd. and is loaned to the recipient subject to return upon demand. Its contents are confidential and must not be copied or submitted to outside parties.</p>		
	<p>PROJ. NO.</p>	<p>TITLE : X-SHEAR (600MM) W/AUTOMATIC STACKER GENERAL ARRANGEMENT (600mm剪切机与自动叠片机总体布置图)</p>		
<p>ASSEMBLY NO.</p>	<p>DATE 05/09/2014</p>	<p>SCALE 1:60</p>	<p>REV. 0</p>	
<p>DRAWN BY JRC</p>	<p>APPROVED</p>	<p>DWG. NO. 2261-full line</p>	<p>SHEET NO. 2 OF 3</p>	



NOTE: UNLOADING CARTS NOT SHOWN
备注: 卸料车未在图中显示

	<small>UNITS (SI) - SI UNITS SPECIFIED</small> <small>FRACTIONAL SIZES</small> <small>MILLIMETER</small> <small>METRIC</small> <small>1/16" = 1.5875</small> <small>1/8" = 3.175</small> <small>3/16" = 4.7625</small> <small>1/4" = 6.35</small> <small>5/16" = 7.9375</small> <small>3/8" = 9.525</small> <small>1/2" = 12.7</small> <small>5/8" = 15.875</small> <small>3/4" = 19.05</small> <small>1" = 25.4</small>	<small>This print is the property of Micro Tool & Machine Ltd. and is loaned to the recipient subject to return upon demand. Its contents are confidential and must not be copied or submitted to outside parties.</small>
	<small>PROJ. NO.</small> <small>ASSEMBLY NO.</small>	<small>TITLE:</small> X-SHEAR (600MM) W/AUTOMATIC STACKER GENERAL ARRANGEMENT (600mm 剪切机与自动叠片机总体布置图)
<small>DRAWN BY:</small> JRC	<small>DATE:</small> 05/09/2014	<small>SCALE:</small> 1:60 <small>REV:</small> 0
<small>APPROVED:</small>	<small>DWG. NO.:</small> 2261-Full line	<small>SHEET NO.:</small> 1 <small>OF:</small> 3

【P20】 Technical Data 技术参数

Parameter 参数说明	Specification 参数
Maximum length of cut along centerline 中线最大剪切长度	3,500 mm
Minimum length of cut along centerline 中线最小剪切长度	500 mm
Maximum core steel width 最大剪切宽度	610 mm
Minimum core steel width 最小剪切宽度	50 mm
Core steel thickness 矽钢片厚度	0.19 - 0.35 mm (片厚度改变时, 引导系统无需调整)
Maximum step lap size 最大步进尺寸	40 mm from centerline 沿中线
Increments of step lap 叠片步数	1, 3, 5, 7 vertical; programmable 垂直步进
Position hole diameter 定位孔直径	8.3 mm(standard) or 0.375 in.
Core bolting hole diameter 螺栓孔直径	Standard sizes 标准 : 16 - 22mm 用户选择
Repeatability accuracy, length 剪切精度	<± 0.2 mm
Maximum burr on sheared core steel 最大毛刺	< 0.02 mm
Shear blade cycles before re-sharpening 剪切刀研磨	> 1 million 次 (每个刀片均配有独立运行计数器) 刀片材料为整条硬质合金
Feeding capacity 电机进给能力	250 m/min
Production rate with P20 Stacker (average, precision stacked) P20 型号配置剪切并叠片速度	30 - 40 Sheets/Min 片/分
Pile stacking accuracy 叠片理料精度 (堆垛)	~ ± 1.0 mm (无需定位销堆垛)
Same-time Stacking cores 同时剪叠铁芯数量	Up to 6 cores (30 Logs) 上到 6 个铁芯 (30 铁柱) 见叠片模式附图
Pile stacking cart capacity each side 叠片台承重	10,000 kg / 台
Safety system 系统安全	Laser beam detection 激光探测
System Measurement 剪切线整体尺寸 (包括理料)	12m x 5.5m x 2.0m (长 x 宽 x 高)
Power requirements 供电容量	20 KVA total peak, 1 and 3 phase, 50-60 Hz voltages to suit
Air supply 压缩空气	Pressure - 6.2 bar (continuously 连续) Volume - 0.4 cubic meters / min. (continuously 连续) Supply Air Line - 16 mm 气管

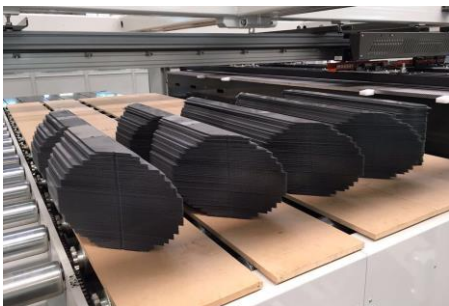

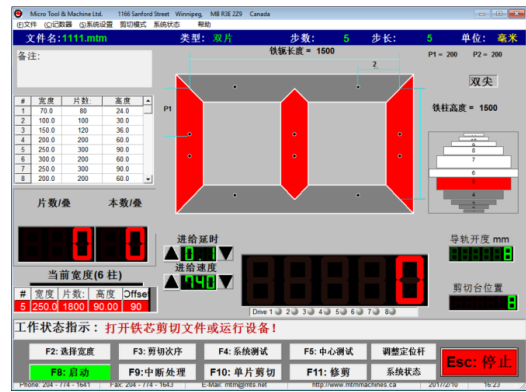
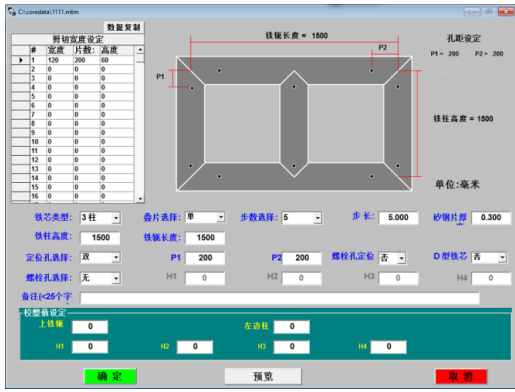

MTM 特点 Customer Benefit 选择理由

50 years in operation 运营 50 年的公司	Proven products with 50 years of experience with customers in over 40 countries around the world. 50 年的经验，销售全球 40 多个国家
Established Machine Design 自主知识产权的设计	MTM has produced the XS-600 for 24 years. Own a Patent of USA . The design has proven capabilities and has been successfully delivered to customers worldwide. Stacking system has a Patent of China . MTM X 型剪切机构拥有美国专利，经历 24 年的历史。成功地被全球用户接受。叠片系统拥有中国专利。
Technical Support in Multiple Languages 多种语言的技术支持	MTM has ability to support technical questions in multiple languages (French, English, German, Russian, Mandarin, and Spanish) MTM 提供英语，法语，德语，中文，俄语，西班牙语的技术支持。
High Productivity 高生产效率	Full sequential cutting combined with automated stacking of multiple transformer cores (at the same time) reduces the need for material change overs, thereby increasing the machine utilization. 全序列剪切与高效自动理料相结合，大量地减少换料时间，节省人力，改善劳动环境，高产出，高性价比，设备总体效率高。
Compact Design, Reduced Factory Space Requirement 设备紧凑减少占地面积	The compact design of MTM machines equals a reduced requirement for factory floor space. This allows valuable space to be used for other activities. 剪叠一体的紧凑设计减少场地面积，节省的场地有利于安排其它用途。
No Looping Pit or Special Foundation Requirements 设备无地坑无需基础	Smooth and easy integration of the MTM cutting line into the existing factory. Installation completed in 1 week. 设备非常容易安置在用户现有场地，安装过程仅需一周。
Double Core Fabrication 双铁芯同时生产无需叠片	XS-600 with P20 E use robotic control automated cutting and stacking double [E] . Solution provides the ability to maximize production efficiency and dramatically drop labor cost and production space. This reduce human nature involvement much more improve production quality and reduce core loses. P20E 型号采用机器人叠片系统可同时剪叠双 E 铁芯。提供最高生产效率极大地降低劳动成本减少生产空间。减少人为干预改善产品质量降低铁芯损耗,且省矽钢片材料~1%。
Unique Pallets design for pre-staging or setup of upcoming projects 独特的预置托盘设计实现生产过程无缝连接	One pair [E] cores is be cutting, other two pre-setting pallets can be prepared. That will create seamless transfer to next double [E] cores manufacturing. 双“E”在剪切，另外两个“E”托盘可并行设置，从完成对双“E”到开始下一对双“E”，机器无等待时间。
Offer Enterprise Management Function 适应现代化企业管理	IoT (工业4.0) 的一些需求，如实时在线信息等…… 从设计部门，可将铁芯数据传送到设备直接生产。 提供给企业数据库数据，便于精确计算生产工时，每班效率及生产成本等，便于优化 CRM (用户资源管理) 及 ERP (企业资源管理)。为下一步创建铁芯生产的无人自动化工厂的目标打下坚实基础，使企业迈入无人车间、无人工厂。